

A-A (1 : 11)

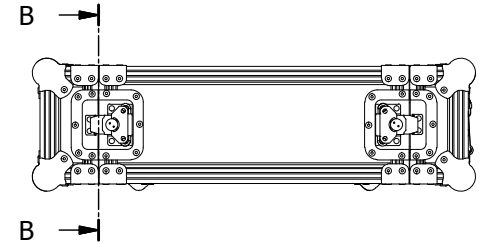

B-B (1 : 11)

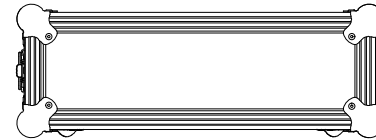
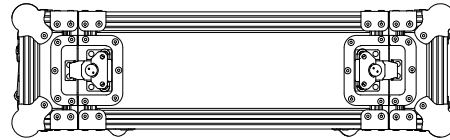
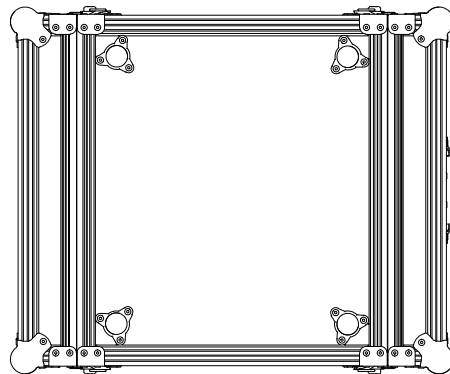
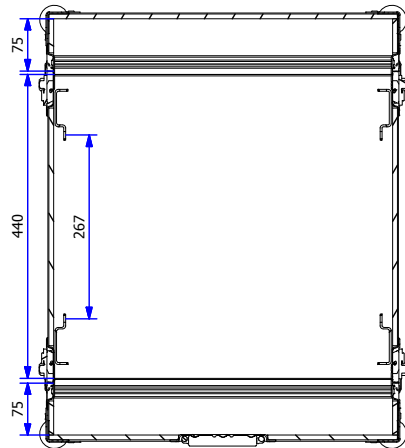

External Dimensions (excluding hardware): 510W x 623D x 170 H



Parts List	
QTY	DESCRIPTION
8	Medium Ball Corner 4120
16	L-Bracket 4043
1	Recessed Flip Handle 34082
4	Medium Padlocking Butterfly Catch L908/915/07
4	Steel Foot 4936
4	Double Full Hole Rackstrip R0883
1	12mm LD18 Sleeve Bottom
1	Dragon Badge

Drawing no:	Figure	Sheet	Wall Thickness:	Wall Colour/Material:	Hardware Details:	Specifications:	ALL DIMENSIONS IN MILLIMETRES	 DO NOT SCALE	THIS DRAWING IS COPYRIGHTED BY DRAGON CASES. IT MUST NOT BE COPIED OR DISCLOSED WITHOUT CONSENT OF THE OWNER	 DRAGON CASES in partnership with Nomad PLC tel: 01633 791590 fax: 01633 791531
F193USTD	1	1	7mm	7mm Laminated ply/Astraboard	See parts list.	1. Aluminium extrusions riveted through wall material every 100mm. 2. Bifurcated rivets to be used wherever possible. 3. All hardware zinc plated. 4. 12mm LD18 foam in sleeve base. 5. Rack rails front + rear. 6. Estimated weight - 9.8kgs.				
Title:	Drawn by:	Date:	Company:							

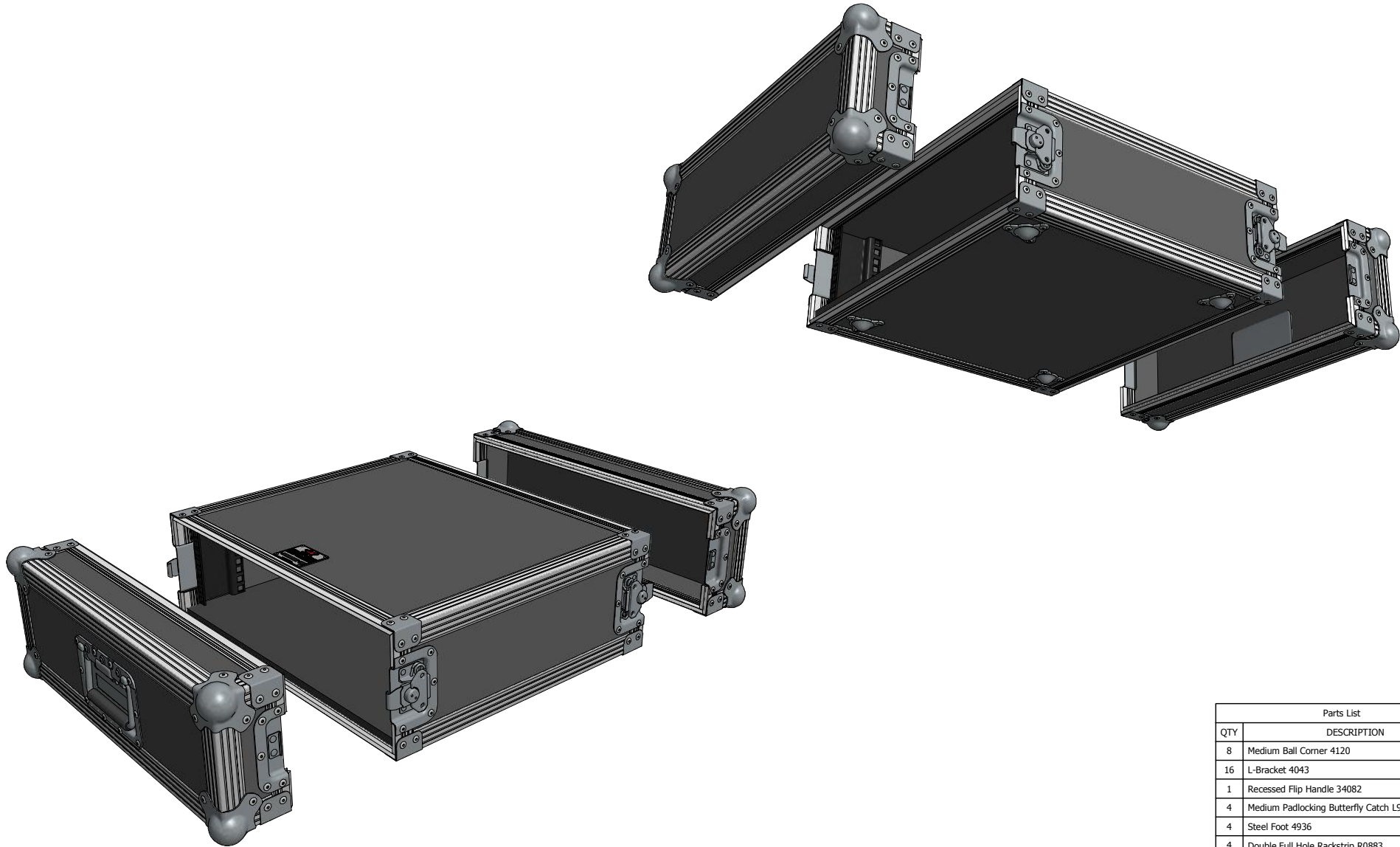
3u Standard 19" Rack Flightcase with 440mm Sleeve	J.B.	08/10/2008	AN Other
---	------	------------	----------



Parts List	
QTY	DESCRIPTION
8	Medium Ball Corner 4120
16	L-Bracket 4043
1	Recessed Flip Handle 34082
4	Medium Padlocking Butterfly Catch L908/915/07
4	Steel Foot 4936
4	Double Full Hole Rackstrip R0883
1	12mm LD18 Sleeve Bottom
1	Dragon Badge

Drawing no: F193USTD	Figure: 1	Sheet: 3	Wall Thickness: 7mm	Wall Colour/Material: 7mm Laminated ply/Astraboard	Hardware Details: See parts list.	Specifications: 1. Aluminium extrusions riveted through wall material every 100mm. 2. Bifurcated rivets to be used wherever possible. 3. All hardware zinc plated. 4. 12mm LD18 foam in sleeve base. 5. Rack rails front + rear. 6. Estimated weight - 9.8kgs.	ALL DIMENSIONS IN MILLIMETRES  DO NOT SCALE	THIS DRAWING IS COPYRIGHTED BY DRAGON CASES. IT MUST NOT BE COPIED OR DISCLOSED WITHOUT CONSENT OF THE OWNER	 DRAGON CASES in partnership with Nomad PLC tel: 01633 791590 fax: 01633 791531
Title: 3u Standard 19" Rack Flightcase with 440mm Sleeve			Drawn by: J.B.	Company: AN Other					
			Date: 8/10/08						