

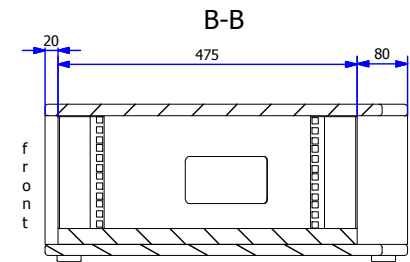

42mm holes
7mm deep

34082B
Black Handles

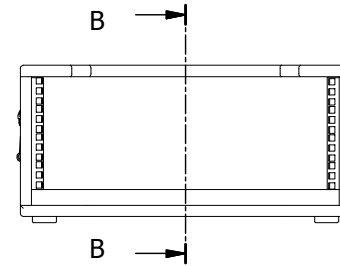
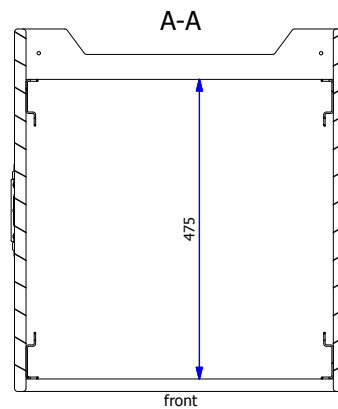
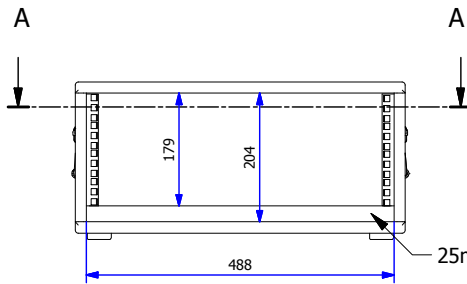
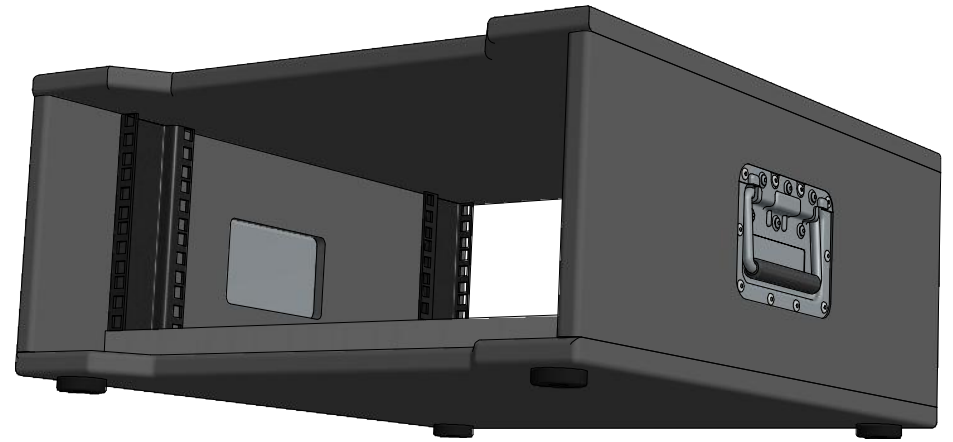
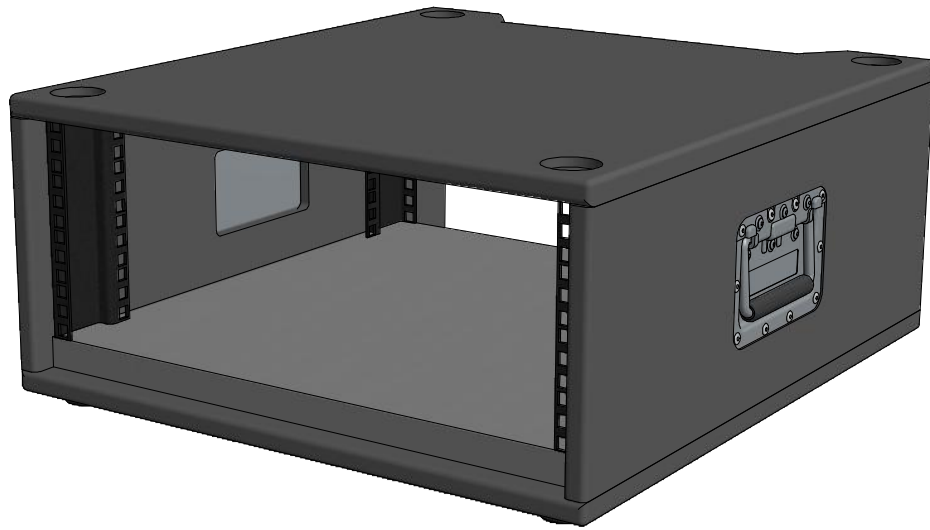

Drawing no: F7054	Issue No: 1	Sheet: 1	Wall Thickness: 18mm	Wall Colour/Material: 18mm birch ply painted black	Hardware Details: Black Recessed flip handles. 38mm x 10mm rubber feet. 4u Double punched full holed rack strips.	Specifications: 1. Joints to be glued, screwed and holes filled. 2. All edges bull nosed. 3. Recessed handles to have flanges recessed in to ply surface.	ALL DIMENSIONS IN MILLIMETRES DO NOT SCALE	THIS DRAWING IS COPYRIGHTED BY DRAGON CASES. IT MUST NOT BE COPIED OR DISCLOSED WITHOUT CONSENT OF THE OWNER	 DRAGON CASES in partnership with Nomad PLC tel: 01633 791590 fax: 01633 791531
Title: 4u Rack Pack Sleeve			Drawn by: J.B.	Company: XX					
			Date: 16/02/2010						



Drawing no:	F7054	Issue No:	1	Sheet:	1	Wall Thickness:	18mm	Wall Colour/Material:	18mm birch ply painted black	Hardware Details:	Black Recessed flip handles. 38mm x 10mm rubber feet. 4u Double punched full holed rack strips.	Specifications:	1. Joints to be glued, screwed and holes filled. 2. All edges bull nosed. 3. Recessed handles to have flanges recessed in to ply surface.	ALL DIMENSIONS IN MILLIMETRES	THIS DRAWING IS COPYRIGHTED BY DRAGON CASES. IT MUST NOT BE COPIED OR DISCLOSED WITHOUT CONSENT OF THE OWNER	 DRAGON CASES in partnership with Nomad PLC tel: 01633 791590 fax: 01633 791531
Title:	4u Rack Pack Sleeve	Drawn by:	J.B.	Company:	XX	Date:	16/2/10					 3rd ANGLE PROJECTION DO NOT SCALE				