

FRONT

Panel & Interior Details
REAR

RIGHT

A ← LEFT

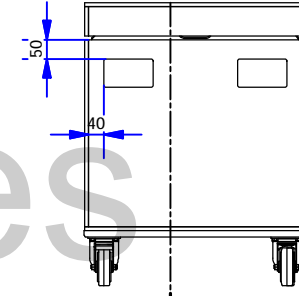
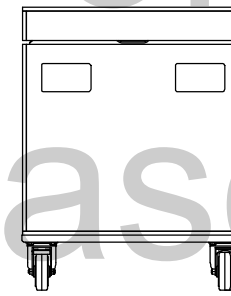
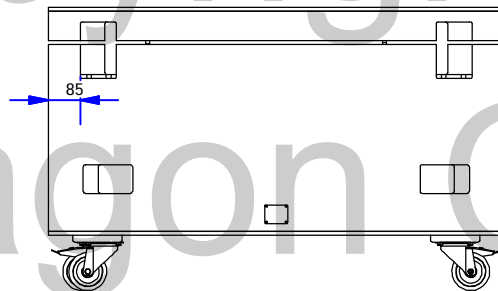
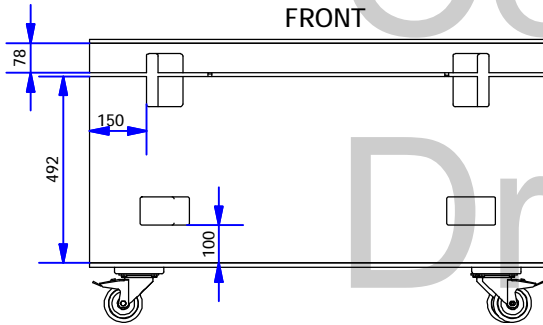

BASE VIEW

Moveable Partition x2

A-A

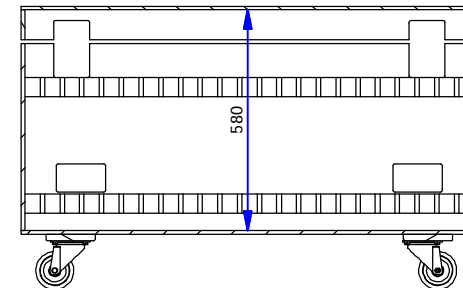
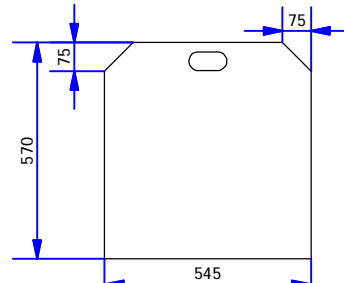
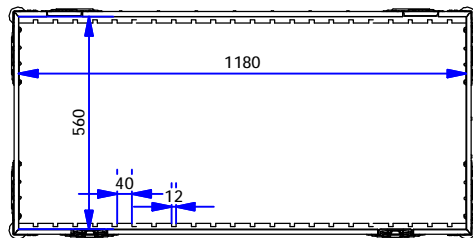

External Dimensions (excluding hardware); 1206L x 586W x 603H

Drawing no: FFT3	Issue No: 1	Sheet 1	Wall Thickness: 10mm	Wall Colour/Material: Laminated/Phenol Faced Ply	Hardware Details: Piano hinged lid with stays. Recessed butterfly catches. Recessed flip handles with rubber grips. Steel ball corners + L/T brackets. 100mm swivel castors (2 braked).	Specifications: 1. Aluminium extrusions riveted through wall material every 100mm. 2. Bifurcated rivets to be used wherever possible. 3. All hardware zinc plated. 4. No Foam Lining	ALL DIMENSIONS IN MILLIMETRES 3rd ANGLE PROJECTION DO NOT SCALE	THIS DRAWING IS COPYRIGHTED BY DRAGON CASES. IT MUST NOT BE COPIED OR DISCLOSED WITHOUT CONSENT OF THE OWNER	 DRAGON CASES in partnership with Nomad PLC tel: 01633 791590 fax: 01633 791531
Title: Flexi Trunk 3			Drawn by: IC	Company: AN Other					