

Birch ply sleeve with Aluminium Capping encased in 25mm High Density foam

Panel & Interior Details

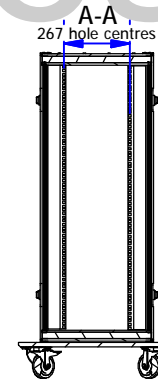
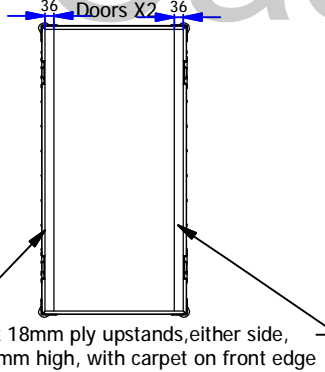
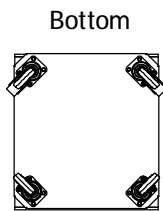
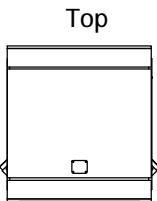
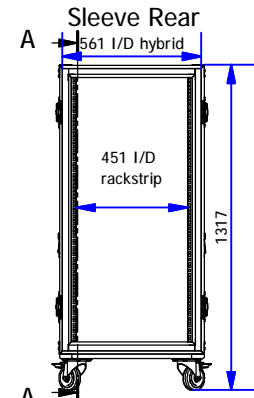
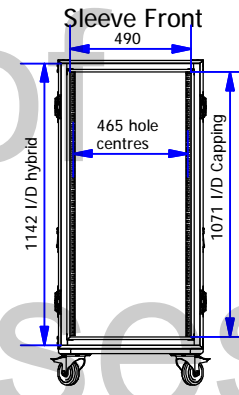
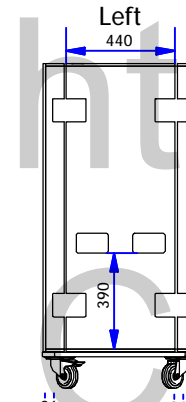
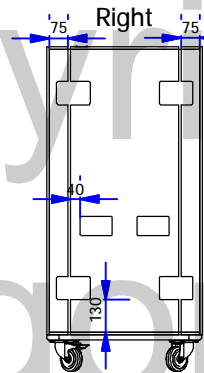
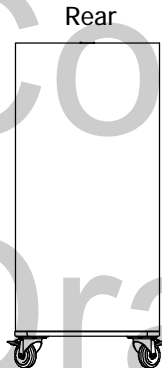
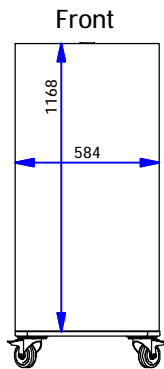

External Dimensions (excluding hardware): 587W x 633D x 1168H

Drawing no: <b>F1924UFS</b>	Issue No: 1	Sheet No: 1	Wall Thickness: <b>10mm</b>	Wall Colour/Material: <b>Laminate/Phenol faced ply</b>	Hardware Details: Recessed butterfly catches. Recessed flip handles with rubber grips. Steel ball corners + L/T brackets. Steel punched rackstrips front + rear. 100mm swivel castors (2 braked)	Specifications: 1. Aluminium extrusions riveted through wall material every 100mm. 2. Bifurcated rivets to be used wherever possible. 3. All hardware zinc plated. 4. 9mm Ply enclosure with aluminium capping suspended with 25mm high density foam.	ALL DIMENSIONS IN MILLIMETRES 3rd ANGLE PROJECTION DO NOT SCALE	THIS DRAWING IS COPYRIGHTED BY DRAGON CASES. IT MUST NOT BE COPIED OR DISCLOSED WITHOUT CONSENT OF THE OWNER	 <b>DRAGON CASES</b> In partnership with Nomad PLC tel: 01633 791590 fax: 01633 791531
Title: <b>24u Foam Suspended Rack Flightcase with 440mm Sleeve</b>			Drawn by: IC	Company: AN Other					
			Date: 28/10/2008						