

Internal Subframe suspended with 8 rubber shockmounts (weight bearing 50Kg,90Kg or 200Kg)

Panel & Interior Details

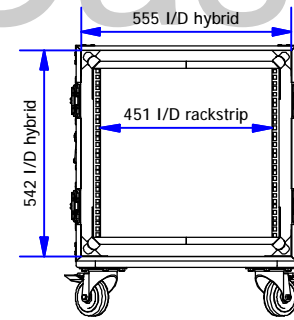
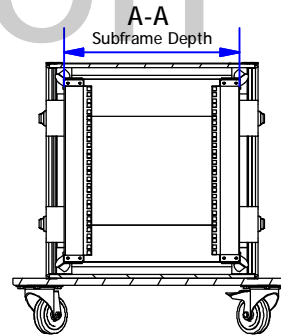
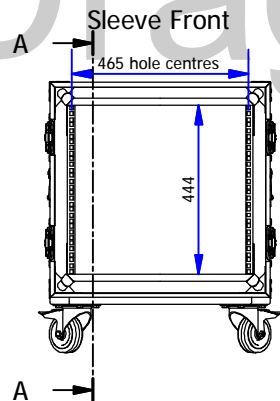
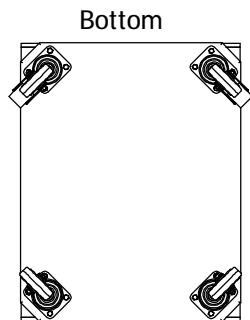
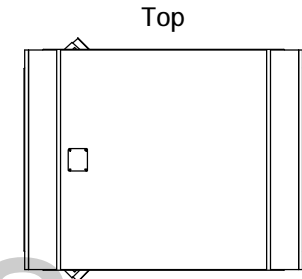
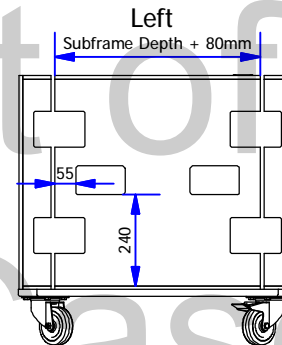
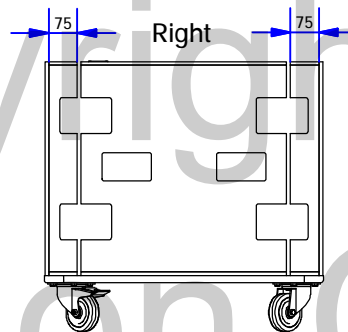
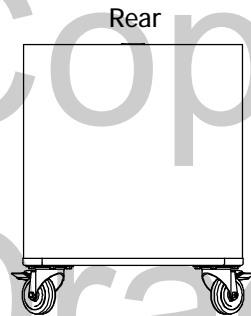
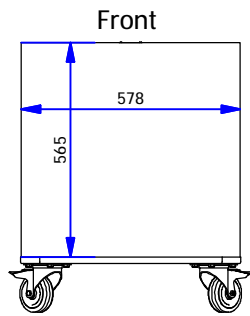

Available Subframes	
Subframe Depth	Panel Depth
362mm	442mm
407mm	482mm
462mm	542mm
507mm	587mm
562mm	642mm
607mm	687mm
662mm	742mm
707mm	787mm
762mm	842mm
807mm	887mm

NOTES
xxxkg Shockmounts

External Dimensions (excluding hardware) - 581W x XXXD x 568H

Drawing no: F1910USM	Issue/Sheet 1 / 1	Wall Thickness: 10mm	Wall Colour/Material: Laminate/phenol faced ply	Hardware Details: Recessed butterfly catches. Recessed flip handles with rubber grips. Steel ball corners + L/T brackets. Steel punched rackstrips front + rear. 100mm swivel castors (2 braked)	Specifications: 1. Aluminium extrusions riveted through wall material every 100mm. 2. Bifurcated rivets to be used wherever possible. 3. All hardware zinc plated. 4. No foam.	ALL DIMENSIONS IN MILLIMETRES 3rd ANGLE PROJECTION DO NOT SCALE	THIS DRAWING IS COPYRIGHTED BY DRAGON CASES. IT MUST NOT BE COPIED OR DISCLOSED WITHOUT CONSENT OF THE OWNER	 DRAGON CASES in partnership with Nomad PLC tel: 01633 791590 fax: 01633 791531
Title: 10u Shockmounted Rack Flightcase with XXXmm Subframe		Drawn by: IC	Company: AN Other					
		Date: 05/11/2008						